

重载连接器产品简介

HDC Product Introduction



2024

CONTENTS
目录

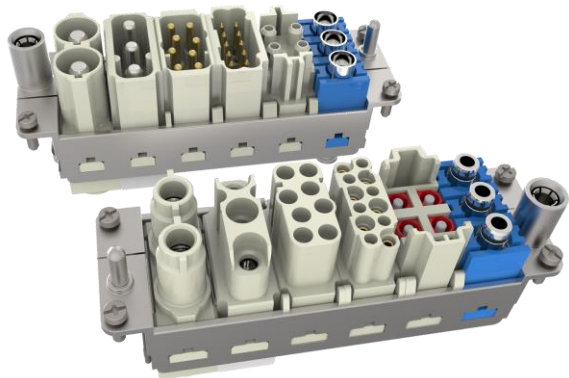

1

产品product

2

工具tool

3

选型model selection

4

应用业绩Application performance

1

产品product



重载连接器的组成

Composition of connectors

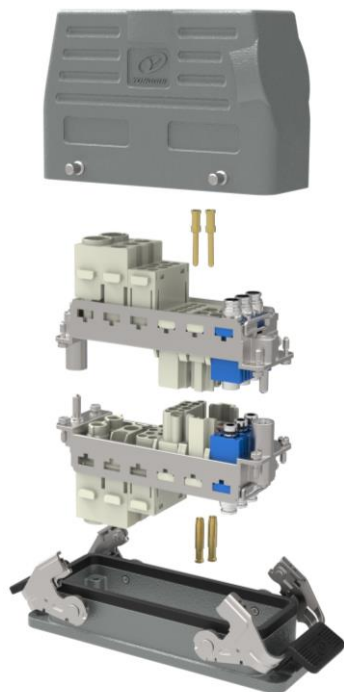

上壳Hoods

接触件Crimp contact

插芯Crimp termination

柜架Hinged frame plus

下壳Housings





A系列外壳 A-series Hoods



24A



16A



10A



6A



3A





A系列外壳 A-series Hoods



32A

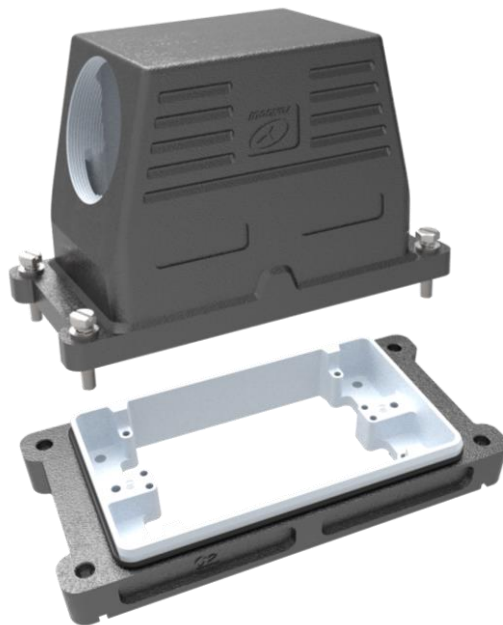

48A





24A加高

24A heighten

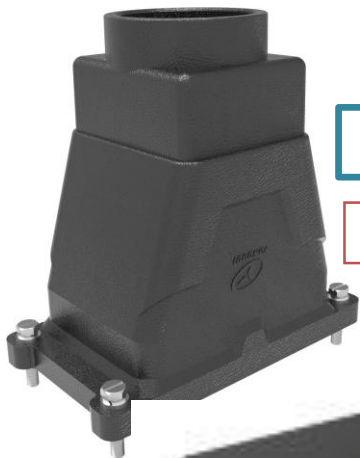

32A加高

32A heighten



A系列基座类,
全系均已开发

A-series base class, All
series have been developed



24A卧式

24A horizontal type



3A卧式

3A horizontal type



A系列外壳 A-series Hoods



替代泰科的壳体，我司
除24A外均已开发

Replacing the shell of TE, Our
company has developed all but
24A





B系列外壳 B-series Hoods



24B



16B



10B



6B



3B



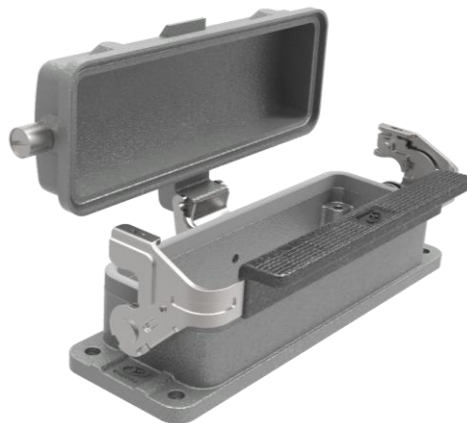
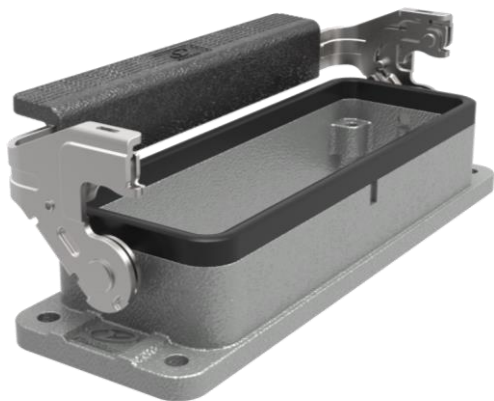

单侧手把，全系均已开发

Single handlebar, All series have
been developed

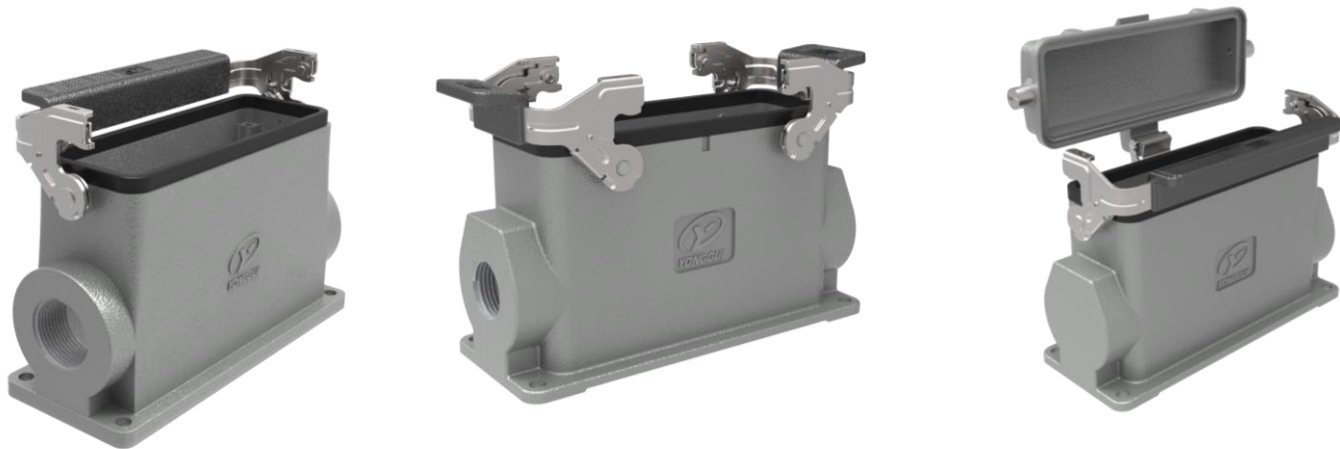

B系列基座类，全系均已开发

B-series base class, All series
have been developed



高结构插头壳体，
目前已开发24B、
16B，10B、6B
未开发

High structure plug
housing, currently
developed 24B, 16B,
10B, 6B not yet
develope



低结构侧出插头壳体
全系均有开发

Low structure side outlet
plug housing , All series
have been developed



低结构直出插头壳体
全系均有开发

Low structure straight out
plug housing, All series
have been developed



上壳Hoods



柜架frame



下壳Housings

特点

- 1、与现有模块、插芯均可以组合;
- 2、重量降低50%;
- 3、可比金属壳体多装一个模块, 节省空间;
- 4、插座端为后装式, 安装便利。

characteristic

1. Can be combined with existing modules and plugs;
2. Reduce weight by 50%;
3. An additional module can be installed on a metal shell to save space;
4. The socket end is rear mounted, making installation convenient.

目前已开发6B, 16B, 其他待开发

Currently, 6B、16B has been developed, while others are yet to be developed



外壳兼容、框架兼容/
Enclosure compatible、Framework compatible



整体式
/Monolithic

模块式
/Modular

插座端为后装式/The socket
end is rear mounted

同系列多装一个模块/One more
module in the same series



重量降低50%
/Reduce weight by 50%



5601



5603



Crimp termination插芯



模块module

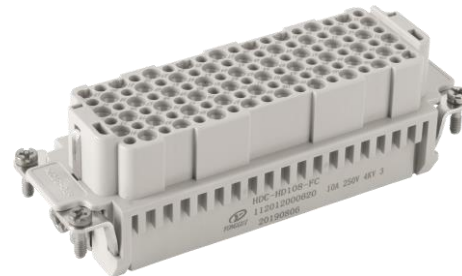

整体whole





10A模块 10A module



12 core

技术参数
额定电压:250V
额定电流: 10A
额定脉冲电压: 4KV



17 core

技术参数
额定电压:160V
额定电流: 10A
额定脉冲电压: 2.5KV



适配接触件

Adapted contact parts

Technical characteristics
Rated voltage: 250V/160V
Rated current: 10A
Rated impulse voltage: 4KV/2.5KV

定位结构比
Harting更可靠

Positioning structure is
more reliable than Harting





16A模块 16A module



6core

8core

20core

技术参数

额定电压:250V

额定电流: 10A

额定脉冲电压: 6KV

Technical characteristics

Rated voltage: 500V

Rated current: 16A

Rated impulse voltage: 6KV



适配接触件

Adapted contact parts





40A模块 40A module



适配接触件

Adapted contact parts

2core

3core

4core

技术参数

额定电压:1000V

额定电流:40A

额定脉冲电压: 8KV

技术参数

额定电压:690V

额定电流:40A

额定脉冲电压: 6KV

技术参数

额定电压:830V

额定电流:40A

额定脉冲电压: 8KV

Technical characteristics

Rated voltage: 1000V/690V/830

Rated current: 40A

Rated impulse voltage: 8KV/6KV/8KV





40A+10A组合模块 40A+10A Combination module



适配接触件

Adapted contact parts

3+4core

技术参数
额定电压:830V
额定电流: 40/10A
额定脉冲电压: 8KV

Technical characteristics
Rated voltage: 500V
Rated current: 16A
Rated impulse voltage: 8KV





70A模块 70A module



技术参数

额定电压: 1000V

额定电流: 70A

额定脉冲电压: 8KV

Technical characteristics

Rated voltage: 1000V

Rated current: 70A

Rated impulse voltage: 8KV





100A模块 100A module



技术参数

额定电压:1000V

额定电流: 100A

额定脉冲电压: 8KV

Technical characteristics

Rated voltage: 1000V

Rated current: 100A

Rated impulse voltage: 8KV





200A模块 200A module



技术参数

额定电压:1000V

额定电流: 200A

额定脉冲电压: 8KV

Technical characteristics

Rated voltage: 1000V

Rated current: 200A

Rated impulse voltage: 8KV





250A模块 250A module



技术参数

额定电压:2000V

额定电流: 250A

额定脉冲电压: 12KV

Technical characteristics

Rated voltage:2000V

Rated current:250A

Rated impulse voltage:12KV





350A模块 350A module



技术参数

额定电压:2000V

额定电流: 350A

额定脉冲电压: 12KV

Technical characteristics

Rated voltage:2000V

Rated current:350A

Rated impulse voltage:12KV





350A模块 350A module



技术参数

额定电压:2000V

额定电流:650A

额定脉冲电压:12KV

Technical characteristics

Rated voltage:2000V

Rated current:650A

Rated impulse voltage:12KV



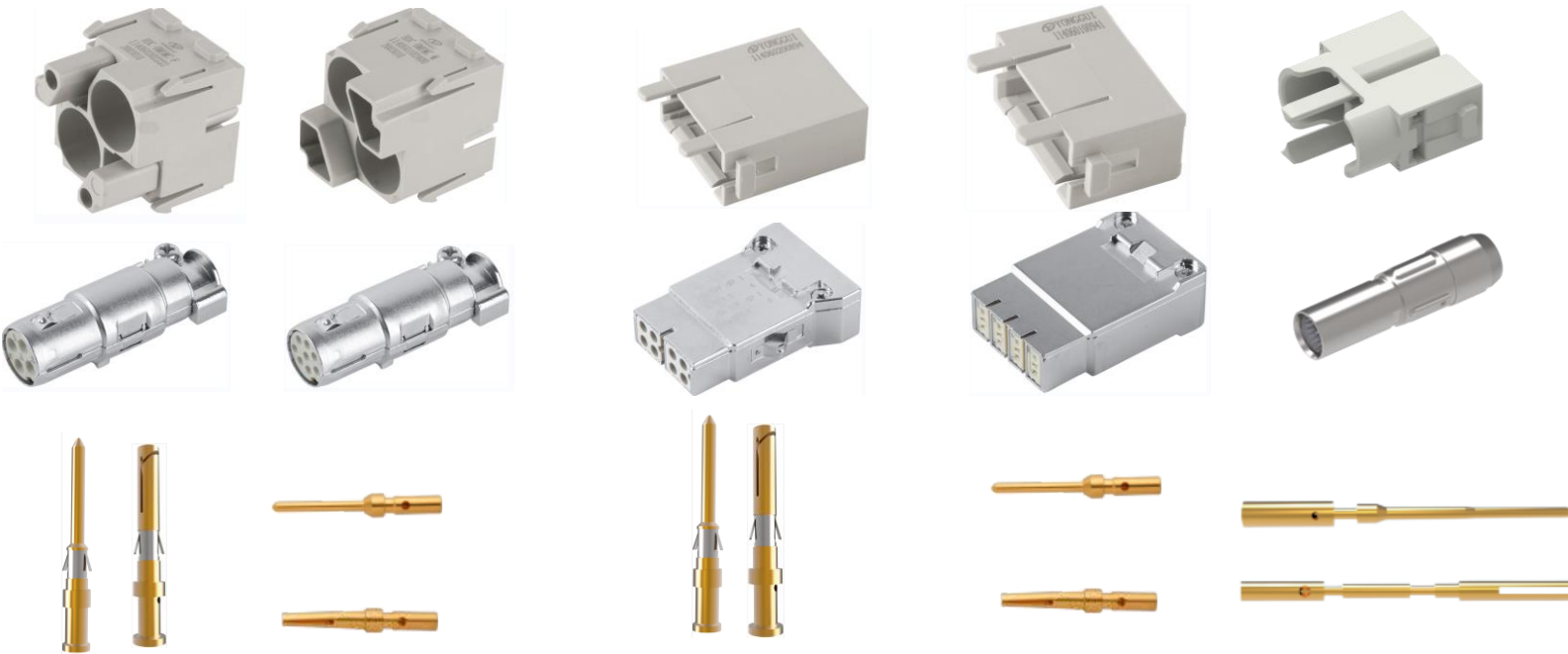

传输速率: 100M

1000M

100M

10000M

10000M

transfer rate



HD系列整体插芯 HD series integral plug

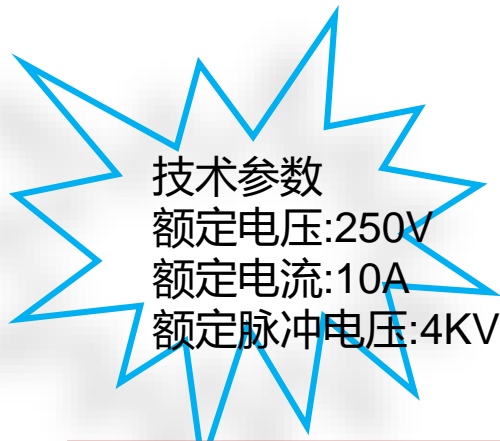

技术参数

额定电压:250V

额定电流:10A

额定脉冲电压:4KV

Technical characteristics
Rated voltage:250V
Rated current:10A
Rated impulse voltage:4KV

We have developed HD24、
HD40、HD42、HD64、
HD72、HD108





HE系列整体插芯 HE series integral plug



技术参数
额定电压:500V
额定电流: 16A
额定脉冲电压:6KV

Technical characteristics
Rated voltage:500V
Rated current:16A
Rated impulse voltage:6KV

We have developed
HE6、HE10、HE10A、
HE16、HE18、HE32、
HE40、HE46、HE64





HQ系列整体插芯 HQ series integral plug



HQ3

HQ4

HQ5

HQ7

HQ12

HQ8



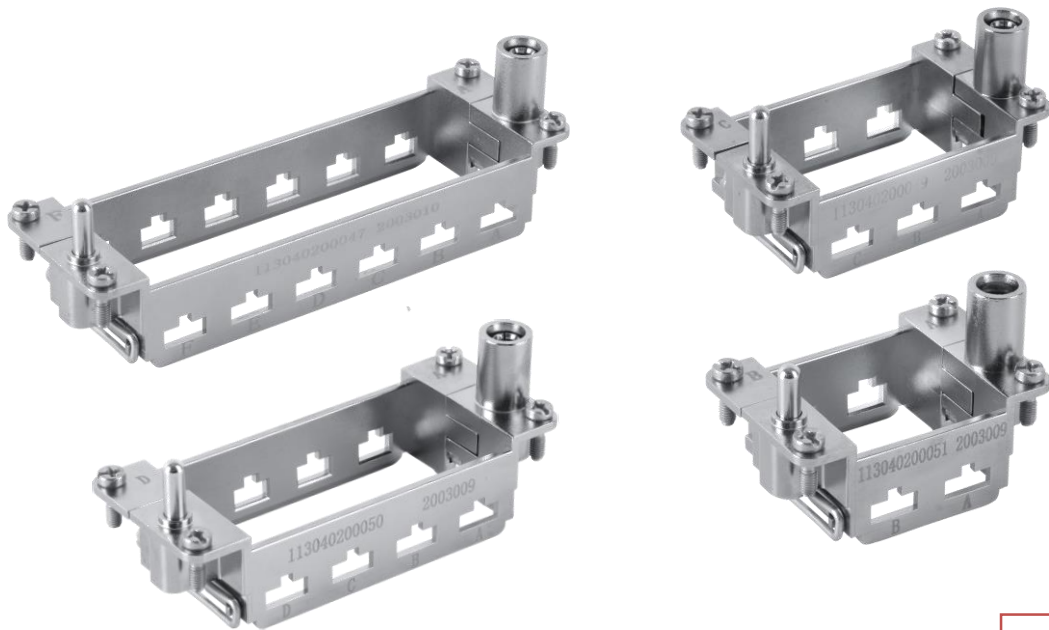

二代铰接框功能展示.mp4

安装模块插芯用

For installing module inserts



安装框架-HC250 Installation framework-HC250

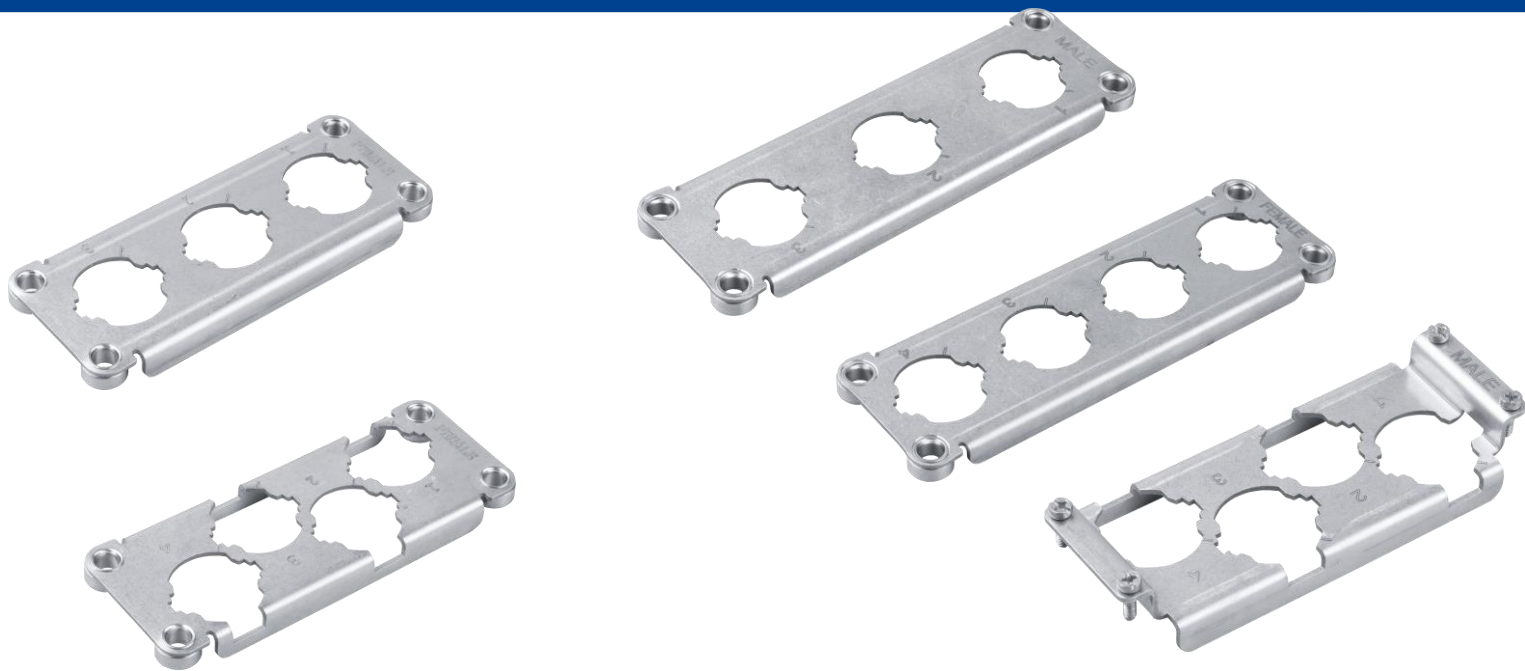

安装250A模块绝缘体用

For installing 250A module insulators





安装框架-HC350 Installation framework-HC350



安装350A模块绝缘体用

For installing 350A module insulators





安装框架-HC650 Installation framework-HC650



安装650A模块绝缘体用

For installing 650A module insulators





编码销Encoding sales

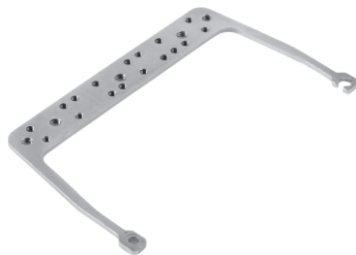

接地板ground plate



线卡Line Card



防护盖protective cover



有壳连接器

Shell connector



把手锁紧
Lock the handle tightly



螺钉锁紧
Screw locking

无壳连接器

nothing Shell connecto





其他矩形连接器 Other rectangular connectors



窄结构连接器

Narrow structure connector



冷压接直角出线电机连接器

Cold pressed right angle outlet motor connector



2

工具tool



取针工具 Needle retrieval tool



HD系列
HDseries



HE系列
HEseries



HC系列
HCseries



HM2C100系列
HM2C100series



HM200系列
HM200series





压接工具Crimp Tools



规格	档位	压接钳	图示
0.14	4	M22520/1-01 (DMC) 531030600020	
0.34	6		
0.50	6		
0.75	6		
1.00	7		
1.50	8		
2.50	8		
4.00	8		
0.14	0.9	KNIPEX四心轴压线钳 (97 52 65) 531030600052	
0.34	1.4		
0.50	1.4		
0.75	1.5		
1.00	1.6		
1.50	1.6		
2.50	1.8		
4.00	1.6		
6.00	2.4		
10.00	2.4		

自制压模配套针孔件的设计，拉脱力符合EN 50343标准要求，且压接后的外观美观。

Design of self-made die matching pinhole parts, The pull-out force meets the requirements of EN 50343 standard, and the appearance after crimping is beautiful



3

选型

model selection



电气性能的选择

Selection of electrical performance



序号	项目	说明
1	连接芯数	确定连接器使用的芯数
2	额定电压	连接系统额定电压，多种电压时，应分别给出
3	额定电流	连接系统额定电流，多种电流时，应分别给出

NO.	project	illustrate
1	CORE	Determine the number of cores used in the connector
2	Rated voltage	When connecting to the rated voltage of the system, multiple voltages should be provided separately
3	Rated current	When connecting the rated current of the system, different currents should be provided separately





外形及安装要求

Appearance and installation requirements



序号	项目	说明
1	安装空间	安装空间尺寸要求, 确定连接器外形及结构形式
2	外形	有壳或无壳
3	连接器连接方式	螺栓或把手锁紧
4	插头出线方式	直出、侧出或多出线口
5	防错插要求	当同种规格连接器装配在相邻位置时, 应考虑防错插要求

NO.	project	illustrate
1	Installation Space	Requirements for installation space size, determination of connector shape and structural form
2	shape	With or without a shell
3	Connector connection method	Bolt or handle locking
4	Plug outlet method	Straight out, side out, or multiple outlet ports
5	Error prevention requirements	When connectors of the same specification are assembled in adjacent positions, anti misinsertion requirements should be considered



4

应用业绩 Application performance



轨交连接器应用 major application of rail crossing connectors



司机台Driver's console



空调系统
air-conditioning system



牵引系统traction system



车端系统Vehicle end system



Key Products – Wind Power Connector Systems

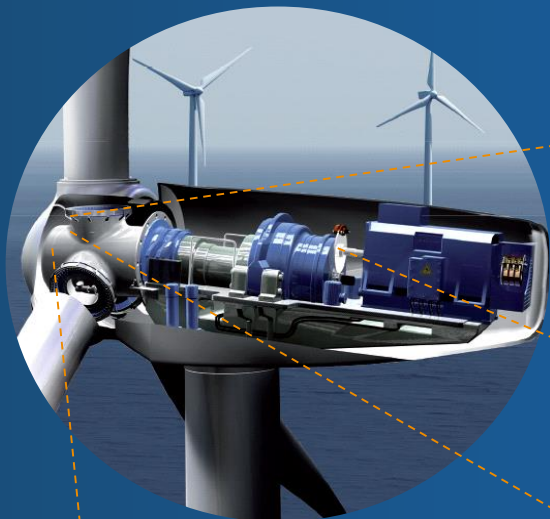

Heavy Duty Connector & cables for control box



Wind power slip ring and connector



Encoder and motor connector



Pitch system



Products – Construction Equipment Connectors

Power & High density signal connector



Sensor connectors



Generator connector

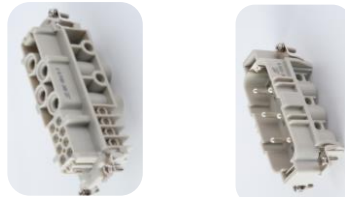

Power connector to electric cabinet



Products – Energy Storage Connectors



Socket box /Wall receptacle



Stacked

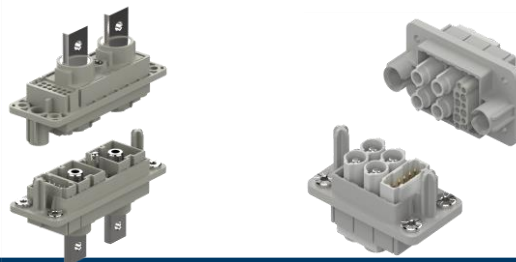

Key Products – Industry 4.0 Connectors



motor encoder and circular power connector



Base cabinet heavy duty connectors





永贵重载连接器产品自2004年开始供货，已在同内外350余个项目上装车，包括纽约、墨西哥和马来西亚等43个国外项目，附供货业绩。

Yonggui HDC connector products have been supplied since 2004 and have been installed on more than 350 projects both domestically and internationally, including 43 foreign projects in New York, Mexico, and Malaysia, with supply performance attached



欢迎您到永贵来

永贵连接 —— 连接专家

Welcome to Yonggui!